

Quality Aluminum Products, Inc.

Quality Aluminum Products, Inc. is a family owned and operated manufacturer of residential aluminum building products. Our product line includes aluminum siding, soffit, fascia, trim coil, and rain carrying products. We also distribute Nailite International Products (brick, stone, and shake), Sheerline (vinyl porch and deck railings), and Decra Stone Coated steel shingles.

The Clark family has been active in the building products industry for nearly 50 years. Bud and Bob Clark began their careers with Wolverine Aluminum in the early 1950's. They started Clark Brothers Metal Fabricators in 1971. Clark Brothers was a manufacturer of residential building products with manufacturing plants in Grosse Ile, Michigan and Orlando, Florida. They also had distribution centers in Nashville, Tennessee, Jacksonville, Tampa, and Sarasota, Florida. In 1984, Clark Brothers was acquired by World Mark Corporation. The Clark brothers stayed on in management positions until 1990 at which time they resigned and started Quality Aluminum Products, Inc. In 1991, they opened the doors with a facility in Flat Rock, Michigan. Quality Aluminum has been blessed with steady growth and currently operates two manufacturing sites. The latest addition is our 110,000 sq. ft. facility located in Hastings, Michigan. This has given us additional room and opportunity for expansion into growing markets.

We currently operate our own fleet of trucks which gives us flexibility and a reputation for excellent delivery services. We currently deliver materials from the East coast to the Midwest and as far as Omaha, Nebraska. We are looking forward to the opportunity to serve your needs in the future. If you have any suggestions on how we can better serve you please call us at 1-800-550-1667.



429 South Michigan Ave • Hastings, MI 49058 • (269) 945-0376 • Fax: (269) 945-0342
14544 Telegraph Road • Flat Rock, MI 48134 • (734) 783-0990 • Fax: (734) 783-1593

Contact us at: www.qualityaluminum.com

Quality Aluminum Products, Inc.



2005 Aluminum Building Products Catalog

Quality Aluminum Products, Inc.

To Whom It May Concern:

This is to certify that our aluminum siding conforms to the Architectural Aluminum Manufacturers Association (AAMA) Specifications sheet 1402.2. AAMA is the recognized trade association for the industry. Although we are not a member of the AAMA, our siding products are produced to meet, and in most cases exceed AAMA specifications.

The most important points of the specifications are: 2.0 Materials, 4.0 Design, Manufacture and Coating of Siding, 7.0 Performance, and 9.0 Fastening.

Under section 2.0 Materials, it talks about aluminum sheet, and what types. We use a 3105 alloy and tempers of H-15 to H-26, which is right in line with AAMA specifications. Also, under this section falls metal thickness, whereby our aluminum is produced by mills such as Commonwealth, to meet the thickness specifications for both .0175 Standard and .021 Deluxe Siding. Sections 4.0 and 7.0 deal primarily with the paint or coating that is applied to aluminum sheet and again the application and performance tests all fall within the AAMA specifications. We currently, and have always used a 10 degree gloss thermal-setting polyester which is produced by Kel-Coatings, LTD., BASF, and backed by a 30 year limited warranty.

Installation specifications for Residential Siding are covered under Specification sheet 1403.3-1981.

In section 9.0 Fastening, it tells how siding is to be applied to the wall. We agree with its statement "nail spacing shall be maximum of 24" o.c. or correspond to stud spacing when application is direct to studs."

Sincerely,

Quality Aluminum Products, Inc.

429 South Michigan Ave • Hastings, MI 49058
(269) 945-0376 • Fax: (269) 945-0342

14544 Telegraph Road • Flat Rock, MI 48134
(734) 783-0990 • Fax: (734) 783-1593

Contact us at: www.qualityaluminum.com

Table of Contents

Aluminum Soffit, Fascia & Accessories	1–6
Aluminum Roof Edges & Mouldings	7–10
Aluminum Starter Strip	11
Galvanized Roof Edges & Starter	12
Aluminum Siding & Accessories	13–15
Colored Coil Stock	16–19
Gutter & Gutter Accessories	20–23
Freight, Policies & Product Specifications	24



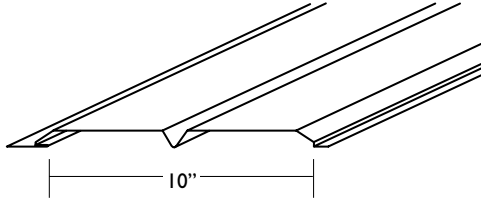
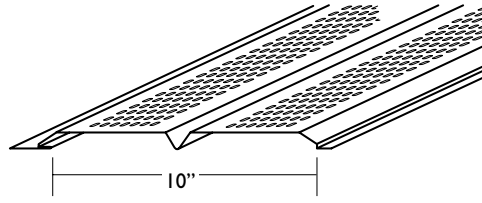
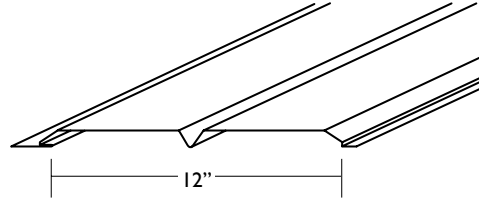
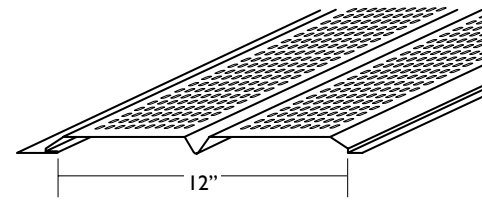

V-Groove Soffit System

Code	Specifications	Description	Colors	Carton Contents
SVPI0		10" Solid V - Panel	102 Pearl Gray 112 Tuxedo Gray 200 Black 202 Royal Brown 204 Grecian Green 223 Imperial Brown 238 Hickory 250 Musket Brown 280 White	10 Pieces 12 Ft. Lgths. To Cover 100 Sq. Ft. 31 Lbs.
LVP10		10" Lanced V - Panel	360 Terratone 713 Wicker 801 Almond 818 Bronze 819 Herringbone 820 Cranberry 821 Ivy 822 Pacific Blue	
SVPI2		12" Solid V - Panel	CW01 Colonial White 102 Pearl Gray 112 Tuxedo Gray 202 Royal Brown 238 Hickory 250 Musket Brown 280 White	10 Pieces 12 Ft. Lgths. To Cover 120 Sq. Ft. 36 Lbs.
LVP12		12" Lanced V - Panel	360 Terratone 713 Wicker 819 Herringbone 841 Buckskin Special Colors on Request	

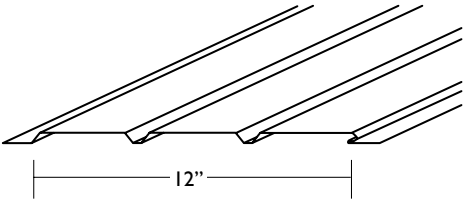
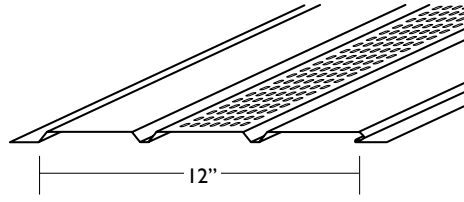
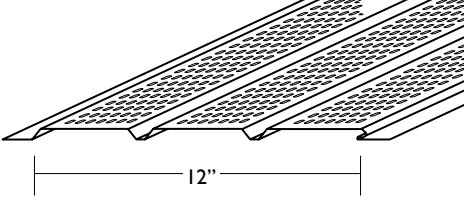
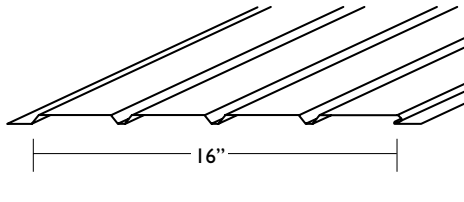
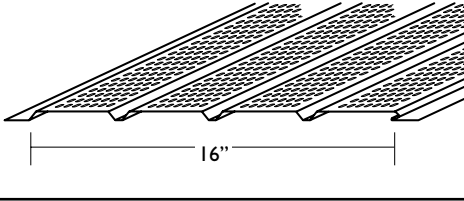
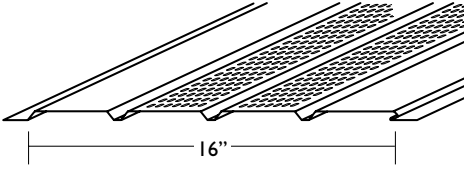
V-Groove Soffit System

Code	Specifications	Description	Colors	Carton Contents
SVPT4		Triple Four Solid V - Panel	CW01 Colonial White 202 Royal Brown 214 Woodland Green 238/336 Hickory/N. Clay 250 Musket Brown 280 White	16 Pieces 12 Ft. Lgths. To Cover 192 Sq. Ft. 57 Lbs.
CVPT4		Triple Four Center Vent V - Panel	325/827 Sandstone Beige/ Champagne 327 Desert Tan 355 Light Maple 360 Terratone 713/334 Wicker/P. Sand 791/350 Norwegian Wood/ Sandtone 792 Heather 793 Sandcastle 801 Almond	
LVPT4		Triple Four Lanced V - Panel	805/397 Pewter/St. Gray 817/326 Cream 819 Herringbone 841 Buckskin 901 Ivory	
SVPQ4		Quad Four Solid V - Panel	202 Royal Brown 214 Woodland Green 238 Hickory 250 Musket Brown	12 Pieces 12 Ft. Lgths. To Cover 192 Sq. Ft. 57 Lbs.
LVPQ4		Quad Four Lanced V - Panel	280 White 360 Terratone 713 Wicker 791/350 Norwegian Wood/ Sandtone	
CVPQ4		Quad Four Center Vent V - Panel	793 Sandcastle 801 Almond 805 Pewter 819 Herringbone	

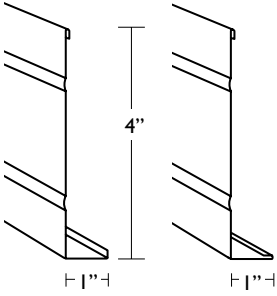
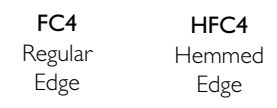
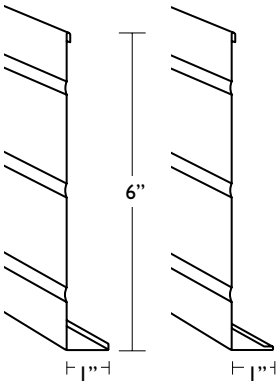
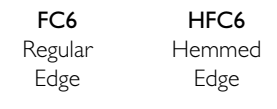
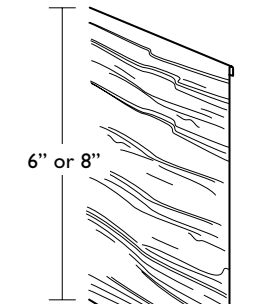
Aluminum Fascia

Code	Specifications	Description	Colors	Carton Contents
FC4		Regular 4" Fascia Cap	202 Royal Brown 223 Imperial Brown 250 Musket Brown 280 White	25 Pieces 12 Ft. Lgths. 300 Ft. Per Carton
HFC4	 FC4 Regular Edge HFC4 Hemmed Edge	Hemmed 4" Fascia Cap	202 Royal Brown 280 White	
FC6		Regular and Hemmed 6" Fascia Cap	102 Pearl Gray 713/334 Wicker/P. Sand 112 Tuxedo Gray 791/350 Norwegian Wood/ 200 Black Sandtone 202 Royal Brown 792 Heather 204 Grecian Green 793 Sandcastle 214 Woodland Green 801 Almond 223 Imperial Brown 805/397 Pewter/St. Gray 238/336 Hickory/ N. Clay 818 Bronze 250 Musket Brown 819 Herringbone 280 White 820 Cranberry 360 Terratone 821 Ivy 822 Pacific Blue 841 Buckskin	25 Pieces 12 Ft. Lgths. 300 Ft. Per Carton
HFC6	 FC6 Regular Edge HFC6 Hemmed Edge	Available in Hemmed Only	*CW01 Colonial White *325/*827 Sandstone Beige/ Champagne *327 Desert Tan *355 Light Maple *817/326 Cream *901 Ivory	
FC6RWNB		Hemmed 6" Fascia Cap Roughwood Embossed Without Beads	238/336 Hickory/N. Clay 280 White 713/334 Wicker/P. Sand 819 Herringbone	25 Pieces 12 Ft. Lgths. 300 Ft. Per Carton
FC8RWNB	 • Roughwood • Hemmed • No Beads	Hemmed 8" Fascia Cap Roughwood	280 White	65 Lbs.
				83 Lbs.

Aluminum Fascia

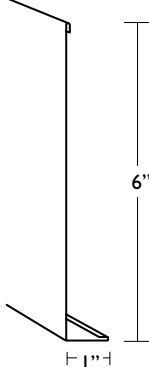
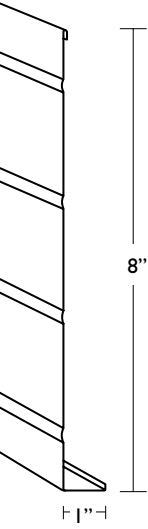
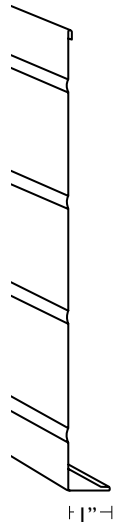
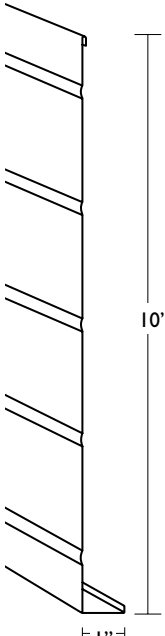
Code	Specifications	Description	Colors	Carton Contents
HFC6NB		Hemmed 6" Fascia Smooth No Bead	238 Hickory 280 White 713 Wicker 791 Norwegian Wood	25 Pieces 12 Ft. Lgths. 300 Ft. Per Carton 65 Lbs.
FC8 HFC8		Regular 8" Fascia Cap	102 Pearl Gray 112 Tuxedo Gray 200 Black 204 Grecian Green 214 Woodland Green 223 Imperial Brown 250 Musket Brown 280 White 360 Terratone 791/350 Norwegian Wood/ Sandtone	25 Pieces 12 Ft. Lgths. 300 Ft. Per Carton 83 Lbs.
			Regular and Hemmed 8" Fascia	
FC10		10" Fascia Cap Regular Only	280 White	20 Pieces 12 Ft. Lgths. 240 Ft. Per Carton 100 Lbs.

Soffit Accessories

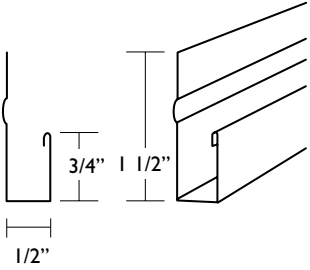
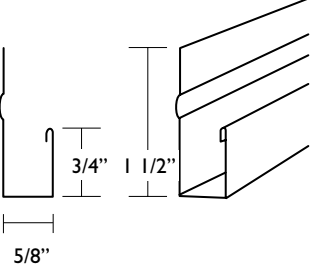
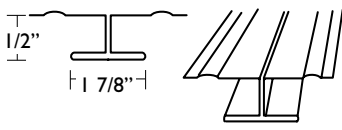
Code	Specifications	Colors	Carton Contents
WFJ5	 <p>1/2" J Channel Moulding</p>	<p>CW01 Colonial White 713/334 Wicker/P. Sand 102 Pearl Gray 791/350 Norwegian Wood/ 112 Tuxedo Gray Sandtone 200 Black 792 Heather 202 Royal Brown 793 Sandcastle 204 Grecian Green 801 Almond 214 Woodland Green 805/397 Pewter/St. Gray 223 Imperial Brown 817/326 Cream 238/336 Hickory/N. Clay 818 Bronze 250 Musket Brown 819 Herringbone 280 White 820 Cranberry 325/827 Sandstone Beige/ Champagne 821 Ivy 327 Desert Tan 822 Pacific Blue 355 Light Maple 841 Buckskin 360 Terratone 901 Ivory</p>	<p>White 50 Pieces 12 Ft. Lgths. 600 Ft. Per Carton</p> <p>35 Lbs.</p> <hr/> <p>Colors 25 Pieces 12 Ft. Lgths. 300 Ft. Per Carton</p> <p>19 Lbs.</p>
J58	 <p>5/8" J Channel Moulding</p>	<p>Certainteed/Wolverine Colors</p> <p>238/336 Hickory/N. Clay 280 White 325/827 Sandstone Beige/ Champagne 327 Desert Tan 355 Light Maple 713/334 Wicker/P. Sand 801 Almond 805/397 Pewter/St. Gray 817/326 Cream 819 Herringbone 833 Sand 901 Ivory</p>	<p>25 Pieces 12 Ft. Lgths. 300 Ft. Per Carton</p> <p>19 Lbs.</p>
DCRI9	 <p>Double Channel Runner</p>	<p>238 Hickory 280 White 713 Wicker</p>	<p>10 Pieces 10 Ft. Lgths. 100 Ft. Per Carton</p>

Soffit Accessories

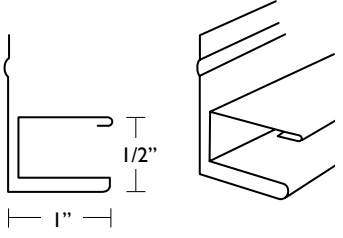
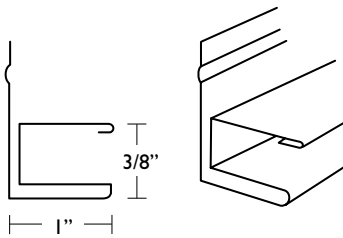
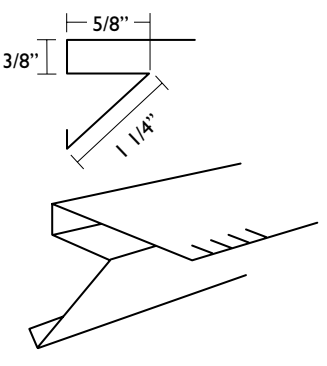
Code	Specifications	Colors	Carton Contents
FR119	 <p>1/2" Frieze Runner</p>	CW01 Colonial White 102 Pearl Gray 112 Tuxedo Gray 200 Black 202 Royal Brown 204 Grecian Green 223 Imperial Brown 238 Hickory 250 Musket Brown 280 White 360 Terratone 713 Wicker 801 Almond 818 Bronze 819 Herringbone 820 Cranberry 821 Ivy 822 Pacific Blue 841 Buckskin	25 Pieces 12 Ft. Lgths. 300 Ft. Per Carton 35 Lbs.
FR38	 <p>3/8" Frieze Runner</p>	CW01 Colonial White 202 Royal Brown 214 Woodland Green 238/336 Hickory/N. Clay 250 Musket Brown 280 White 325/827 Sandstone Beige/ Champagne 327 Desert Tan 355 Light Maple 360 Terratone 713/334 Wicker/P. Sand 791/350 Norwegian Wood/ Sandtone 792 Heather 793 Sandcastle 801 Almond 805/397 Pewter/St. Gray 817/326 Cream 819 Herringbone 841 Buckskin 901 Ivory	25 Pieces 12 Ft. Lgths. 300 Ft. Per Carton 35 Lbs.
RCM19	 <p>Crown Moulding</p>	202 Royal Brown 214 Woodland Green 238/336 Hickory/N. Clay 250 Musket Brown 280 White 360 Terratone 713/334 Wicker/P. Sand 791/350 Norwegian Wood/ Sandtone 793 Sandcastle 801 Almond 805/397 Pewter/St. Gray 819 Herringbone	25 Pieces 12 Ft. Lgths. 300 Ft. Per Carton 35 Lbs.

Aluminum Roofing Materials

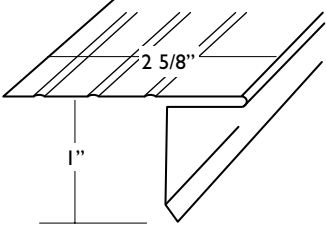
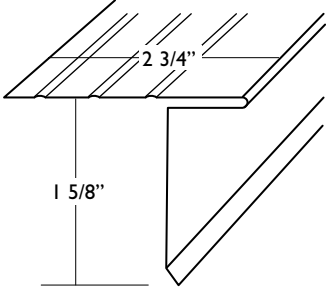
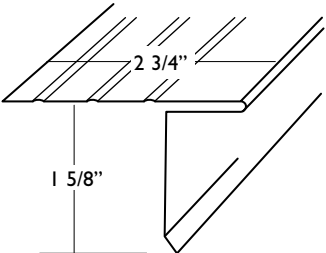
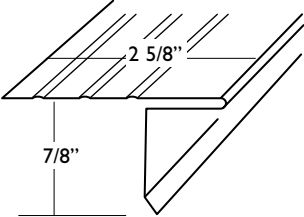
Code	Specifications	Colors		Carton Contents
ADE-45	<p>Style "D" Overhang Drip Edge</p>  <p>36 Boxes Per Pallet</p>	102 Pearl Gray 112 Tuxedo Gray 200 Black 202 Royal Brown 204 Grecian Green 223 Imperial Brown 238 Hickory 250 Musket Brown 280 White 360 Terratone	713 Wicker 801 Almond 805 Pewter 818 Bronze 819 Herringbone 820 Cranberry 821 Ivy 822 Pacific Blue 841 Buckskin	50 Pieces 10 Ft. Lgths. 500 Ft. Per Carton 42 Lbs.
ADE-34	<p>Style "D" Overhang Drip Edge</p>  <p>36 Boxes Per Pallet</p>	102 Pearl Gray 112 Tuxedo Gray 200 Black 202 Royal Brown 204 Grecian Green 214 Woodland Green 223 Imperial Brown 238/336 Hickory/N. Clay 250 Musket Brown 280 White 325/827 Sandstone Beige/ Champagne 327 Desert Tan 355 Light Maple 360 Terratone	713/334 Wicker/P. Sand 791/350 Norwegian Wood/ Sandtone 792 Heather 793 Sandcastle 801 Almond 805/397 Pewter/St. Gray 817/326 Cream 818 Bronze 819 Herringbone 820 Cranberry 821 Ivy 822 Pacific Blue 841 Buckskin 901 Ivory	50 Pieces 10 Ft. Lgths. 500 Ft. Per Carton 48 Lbs.
ADE-3412	<p>12 Ft. Drip Edge</p> 	202 Royal Brown 280 White		25 Pieces 12 Ft. Lgths. 300 Ft. Per Carton 30 Lbs.
ADE342412				45 Lbs.
ADE-4	<p>Style "D" Overhang Drip Edge</p> 	200 Black 202 Royal Brown 280 White		50 Pieces 10 Ft. Lgths. 500 Ft. Per Carton 37 Lbs.

Aluminum Roofing Materials

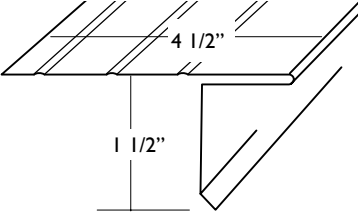
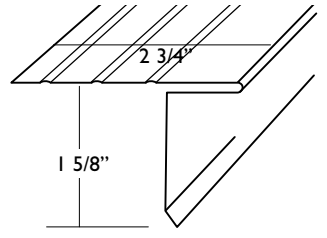
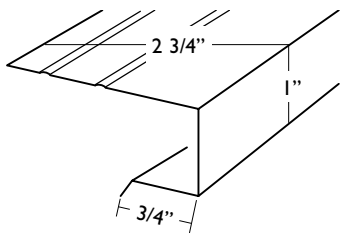
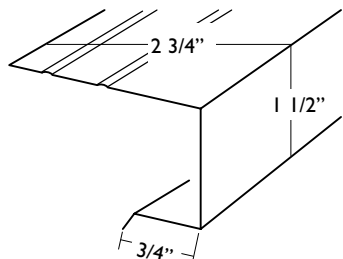
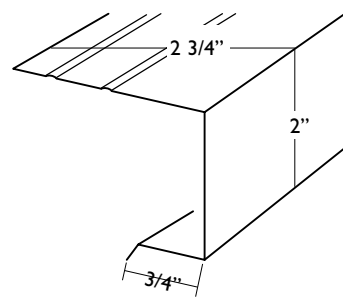
Code	Specifications	Colors	Carton Contents
ADEBB	<p>Big Boy Aluminum Drip Edge</p> 	<p>250 Musket Brown 280 White</p>	<p>50 Pieces 10 Ft. Lgths. 500 Ft. Per Carton</p> <p>69 Lbs.</p>
ADE-34 .024	<p>Style "D" Overhang Drip Edge</p> 	<p>202 Royal Brown 280 White</p>	<p>50 Pieces 10 Ft. Lgths. 500 Ft. Per Carton</p> <p>68 Lbs.</p>
AREC-5	<p>Style "C" Rake Edge</p> 	<p>202 Royal Brown 223 Imperial Brown 280 White 000 Mill Finish</p>	<p>50 Pieces 10 Ft. Lgths. 500 Ft. Per Carton</p> <p>45 Lbs.</p>
AREC-7	<p>Style "C" Rake Edge</p> 	<p>200 Black 202 Royal Brown 223 Imperial Brown 280 White 360 Terratone</p>	<p>50 Pieces 10 Ft. Lgths. 500 Ft. Per Carton</p> <p>48 Lbs.</p>
AREC-9	<p>Style "C" Rake Edge</p> 	<p>202 Royal Brown 280 White</p>	<p>50 Pieces 10 Ft. Lgths. 500 Ft. Per Carton</p> <p>50 Lbs.</p>

Mouldings

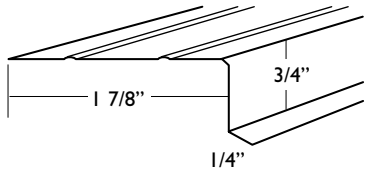
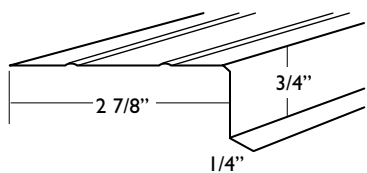
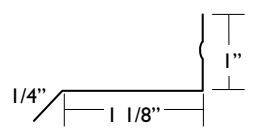
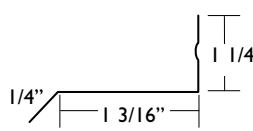
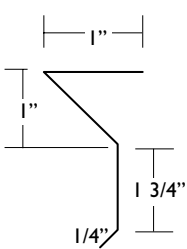
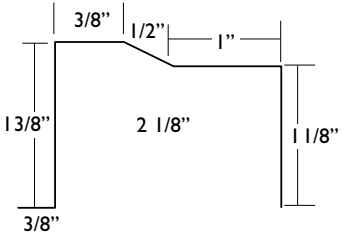
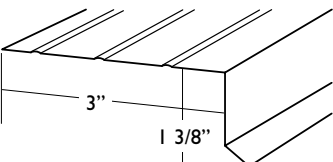
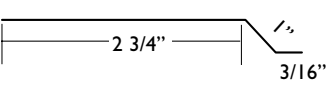
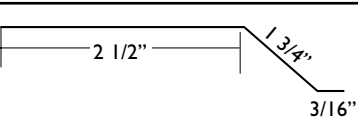
Code	Specifications	Description	Colors	Carton Contents
ARE-12		Style "A" Rake Edge	200 Black 223 Imperial Brown 280 White 360 Terratone	50 Pieces 10 Ft. Lgths. 500 Ft. Per Carton 33 Lbs.
ARE-13		Style "A" Rake Edge	200 Black 223 Imperial Brown 280 White	50 Pieces 10 Ft. Lgths. 500 Ft. Per Carton 40 Lbs.
ADC-18		Drip Cap	280 White	50 Pieces 10 Ft. Lgths. 500 Ft. Per Carton 25 Lbs.
ADC-15		Drip Cap	280 White	50 Pieces 10 Ft. Lgths. 500 Ft. Per Carton 25 Lbs.
SDE		Siders Drip Edge	202 Royal Brown 214 Woodland Green 238 Hickory 250 Musket Brown 280 White 360 Terratone 713 Wicker 791/350 Norwegian Wood/ Sandtone 793 Sandcastle 801 Almond 805 Pewter 819 Herringbone	25 Pieces 10 Ft. Lgths. 250 Ft. Per Carton 21 Lbs.
SBM5		Andersen Brick Moulding	223 Imperial Brown 280 White	20 Pieces 12 Ft. Lgths. 240 Ft. Per Carton 23 Lbs.
ARA-94		Style "A" Rake Angle	200 Black 202 Royal Brown 223 Imperial Brown 280 White 360 Terratone	50 Pieces 10 Ft. Lgths. 500 Ft. Per Carton 42 Lbs.
ARA-61		Aluminum Gutter Apron	200 Black 202 Royal Brown 280 White 360 Terratone	50 Pieces 10 Ft. Lgths. 500 Ft. Per Carton 40 Lbs.
ARA-62			238 Hickory ARA-62 only	42 Lbs.

Aluminum Roof Edge

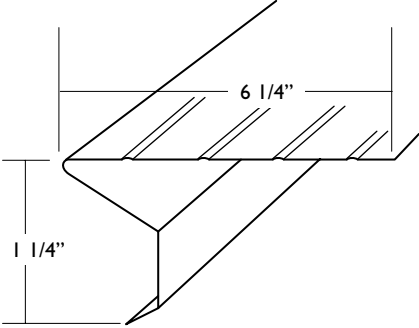
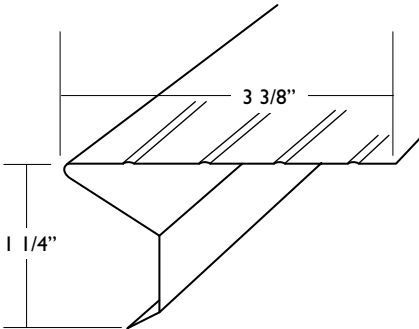
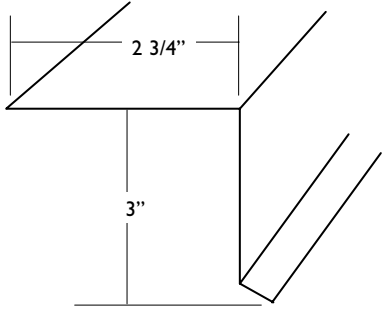
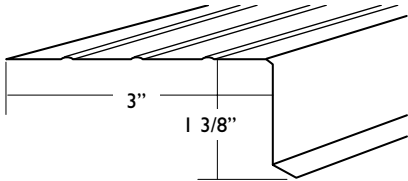
Code	Specifications	Colors	Carton Contents
F8-14 (.014)		Mill Finish 180 High Gloss 250 Musket Brown	50 Pieces 10 Ft. Lgths. 500 Ft. Per Carton 69 Lbs.
F8-18 (.018)			38 Boxes Per Pallet 50 Pieces 10 Ft. Lgths. 500 Ft. Per Carton 88 Lbs.
F5-14 (.014)		Mill Finish 180 High Gloss 250 Musket Brown 200 202 F5-18 280 Only 360	50 Pieces 10 Ft. Lgths. 500 Ft. Per Carton 43 Lbs.
F5-18 (.018)			42 Boxes Per Pallet 50 Pieces 10 Ft. Lgths. 500 Ft. Per Carton 54 Lbs.
C6		Mill Finish 180 High Gloss 818 Bronze	25 Pieces 10 Ft. Lgths. 250 Ft. Per Carton 57 Lbs.
ARA-94 032		Mill Finish 180 High Gloss 818 Bronze	25 Pieces 10 Ft. Lgths. 250 Ft. Per Carton 42 Lbs.

SS & Flashings

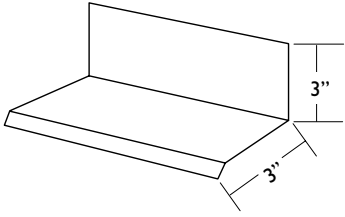
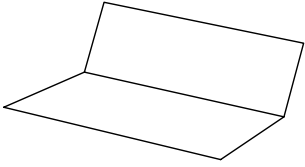
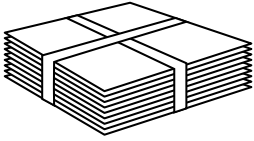
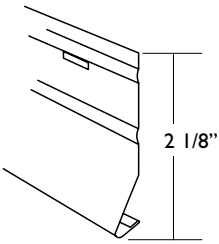
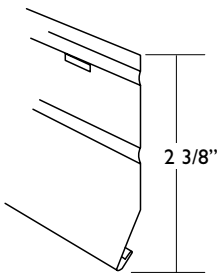
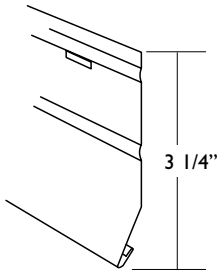
Code	Specifications	Description	Colors	Carton Contents
AWF		Aluminum Wall Flashing	200 Black 223 Imperial Brown 238 Hickory 280 White 360 Terratone 713 Wicker	20 Pieces 10 Ft. Lgths. 200 Ft. Per Carton 24 Lbs.
5x7 PB 7x7 PB 8x8 PB		Pre Bent Flashings	200 Black 202 Royal Brown 280 White 360 Terratone Mill	500 Pieces Per Carton
5 x 7		Flashings	200/202 360/280 Mill	500 Pieces Per Carton
8 x 8				
SSAV		Aluminum Starter Strip for Premium Vinyl Siding 50 Boxes Per Pallet	Mill / Misc	50 Pieces 10 Ft. Lgths. 500 Ft. Per Carton 28 Lbs.
SSAV-12				40 Pieces 12' 6" Lgths. 500 Ft. Per Carton 28 Lbs.
SSAV-5		Aluminum Starter Strip for Narrow Butt Vinyl Siding and Aluminum Siding 50 Boxes Per Pallet	Mill / Misc	50 Pieces 10 Ft. Lgths. 500 Ft. Per Carton 28 Lbs.
SSAV512				40 Pieces 12' 6" Lgths. 500 Ft. Per Carton 28 Lbs.
3SSAV5		Aluminum Starter Strip for Vinyl Siding 50 Boxes Per Pallet	Mill / Misc	50 Pieces 10 Ft. Lgths. 500 Ft. Per Carton 38 Lbs.

Galvanized Roof Edge

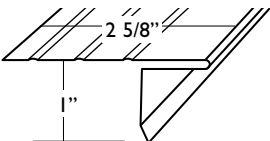
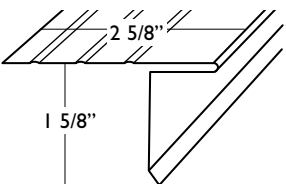
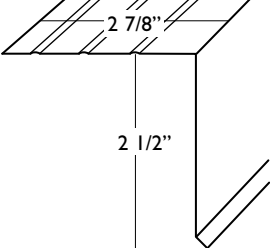
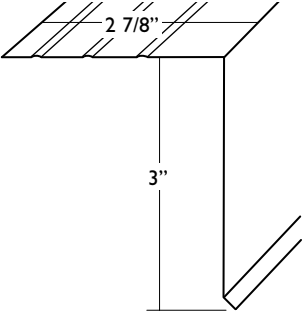
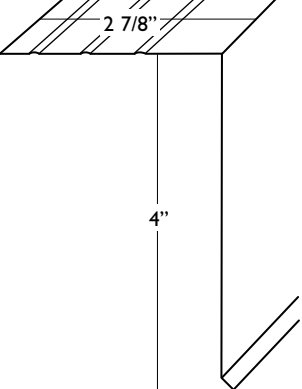
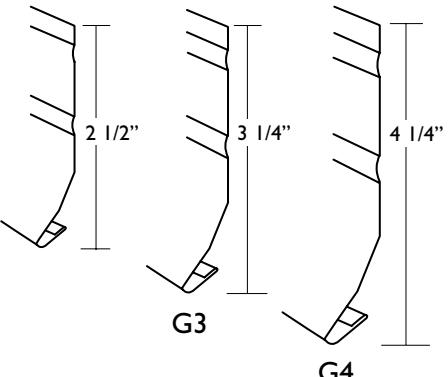
Code	Specifications	Description	Colors	Carton Contents
GDE-45		Galvanized Overhang Drip Edge	202 Royal Brown 280 White	25 Pieces 10 Ft. Lgths. 250 Ft. Per Carton 40 Lbs.
GDE-34		Galvanized Overhang Drip Edge	202 Royal Brown 280 White	25 Pieces 10 Ft. Lgths. 250 Ft. Per Carton 46 Lbs.
GRA325		Galvanized Rake Edge	200 Black 202 Royal Brown 280 White	25 Pieces 10 Ft. Lgths. 250 Ft. Per Carton 73 Lbs.
GRA33		Galvanized Rake Edge	200 Black 202 Royal Brown 280 White	25 Pieces 10 Ft. Lgths. 250 Ft. Per Carton 79 Lbs.
GRA34		Galvanized Rake Edge	200 Black 202 Royal Brown 280 White	25 Pieces 10 Ft. Lgths. 250 Ft. Per Carton 92 Lbs.
GSSV		Galvanized Starter Strip For Vinyl Siding	Mill Finish	40 Pieces 10 Ft. Lgths. 400 Ft. Per Carton 65 Lbs.
G3SSV5				25 Pieces /10 Ft. Lgths. 250 Ft. Per Carton 41 Lbs.
G4SSV5				25 Pieces /10 Ft. Lgths. 250 Ft. Per Carton 56 Lbs.
		50 Boxes Per Pallet		

Horizontal Siding

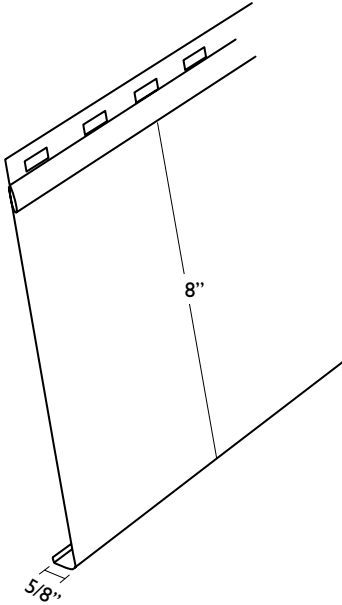
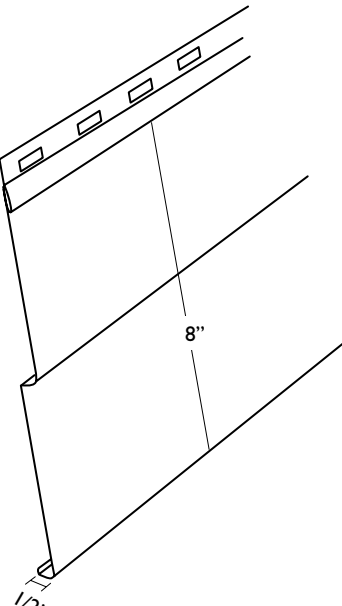

Code	Specifications	Description	Colors	Carton Contents
8HBDSM	 <p>We Recommend Backer Tabs With 8" Siding Seen on Page 15</p>	8" Horizontal Deluxe Smooth	102 Pearl Gray 202 Royal Brown 223 Imperial Brown 238 Hickory 280 White 713 Wicker 801 Almond 841 Buckskin	Width: 8" Length: 12' 6" Pieces: 24 Carton: 2 Sq. 83 Lbs.
8HBDRW		8" Horizontal Deluxe Roughwood	280 White	83 Lbs.
8HBRSM		8" Horizontal Regular Smooth	<i>Special Colors on Request</i>	Width: 8" Length: 12' 6" Pieces : 24 Carton: 2 Sq.
8HBRRW		8" Horizontal Regular Roughwood		72 Lbs.
D4DSM		Double 4" Deluxe Smooth	280 White	Width: 8" Length: 12' 6" Pieces: 24 Carton: 2 Sq.
D4DRW		Double 4" Deluxe Roughwood	<i>Special Colors on Request</i>	90 Lbs.
D4RSM		Double 4" Regular Smooth		72 Lbs.
D4RRW		Double 4" Regular Roughwood	102 Pearl Gray 202 Royal Brown 215 Autumn Red 223 Imperial Brown 224 Woodstock Tan 238 Hickory 280 White 713 Wicker 801 Almond 819 Herringbone 841 Buckskin	Width: 8" Length: 12' 6" Pieces: 24 Carton: 2 Sq. 74 Lbs.

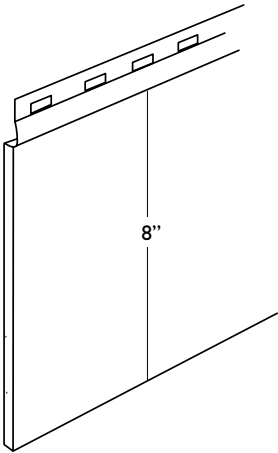
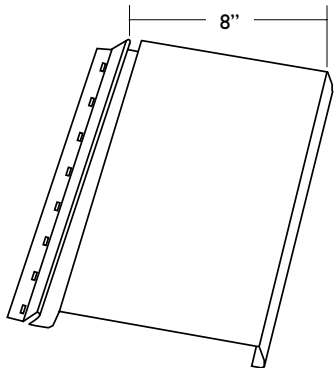
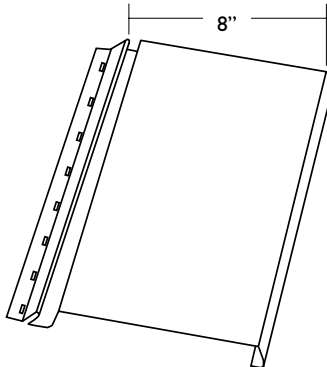
Aluminum Siding

Code	Specifications	Description	Colors	Carton Contents
8FMRSM		8" Foam Insulated Smooth	280 White	Width: 8" Length: 12' 6" Pieces: 12 Carton: 1 Sq. 34 Lbs.
8FMRRW		8" Foam Insulated Roughwood		
8VTDSM		8" Vertical Deluxe Smooth	223 Imperial Brown 238 Hickory 280 White 713 Wicker	Width: 8" Length: 12' 6" Pieces: 12 Carton: 1 Sq. 43 Lbs.
8VTLD		8" Vertical Deluxe Lanced		
8VTDRW		8" Vertical Deluxe Roughwood	280 White	
8VTRSM		8" Vertical Regular Smooth	280 White	Width: 8" Length: 12' 6" Pieces: 12 Carton: 1 Sq. 34 Lbs.
8VTLR		8" Vertical Regular Lanced		

Special Orders: Please allow two weeks for special orders. A minimum of ten squares are required. A 15% upcharge will be applied to all special orders. For orders over 20 squares there is no upcharge. Warranty is void on special order items. There are no returns on special orders.

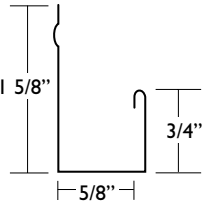
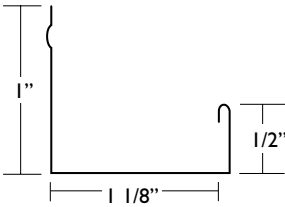
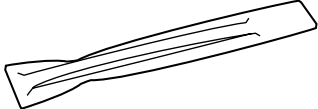
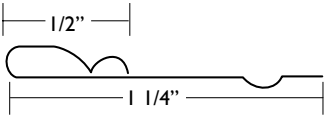
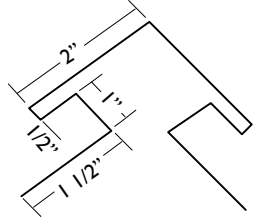
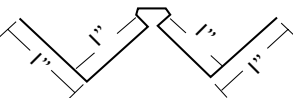
Siding Accessories

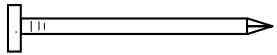
Code	Specifications	Description	Colors	Carton Contents
J58		5/8" J-Channel (Wide Face) Hollowback	102 Pearl Gray 202 Royal Brown 215 Autumn Red 223 Imperial Brown 224 Woodstock Tan 238 Hickory 280 White 713 Wicker 801 Almond 819 Herringbone 841 Buckskin	25 Pieces 12 Ft. Lgths. 300 Ft. Per Carton 25 Lbs.
J-18		1 1/8" J-Channel For Insulated Siding	280 White	50 Pieces 12 Ft. Lgths. 600 Ft. Per Carton 34 Lbs.
B916		Backer Tabs for 8" Hollowback Siding	_____	200 Pieces 41 Lbs.
UT		Utility Trim	All Soffit Colors	50 Pieces 12 Ft. Lgths. 600 Ft. Per Carton 25 Lbs.
BPISM BPIRW		Outside Corner Post Smooth and Roughwood	102, 202, 215, 223, 224, 238, 280, 713, 801, 819, 841	10 Pieces 10 Ft. Lgths. 100 Ft. Per Carton 25 Lbs.
ICIB		Inside Corner Post	280 White <i>Colors Upon Request</i>	20 Pieces 10 Ft. Lgths. 200 Ft. Per Carton 25 Lbs.
POCSM POCRW		Outside Corner Cap Smooth and Roughwood	280 White	100 Pieces 10 Lbs.
SN114 SN112 SN2 SN212		Siding Nails 1 1/4" – 1 1/2" 2" – 2 1/2"	Aluminum	1 Lb. Box 1 Lb.

Colored Coil Stock

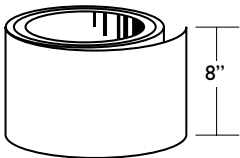
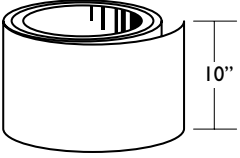
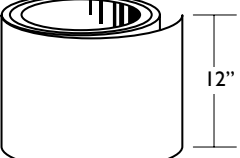
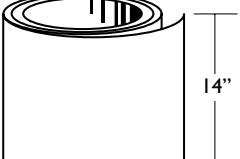
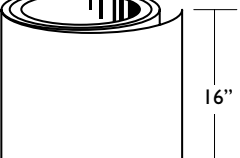
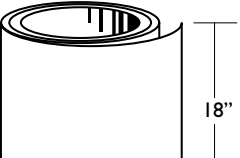
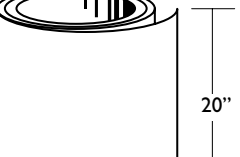
Code	Specifications	Description	Colors	Carton Contents
C-8		8" Trim Coil 8" x 50 Ft.	280/280 White	1 Per Carton 10 Lbs.
C-10		10" Trim Coil 10" x 50 Ft.	280/280 White	1 Per Carton 12 Lbs.
C-12		12" Trim Coil 12" x 50 Ft.	280/280 White	1 Per Carton 14 Lbs.
C-14		14" Trim Coil 14" x 50 Ft.	Mill Finish 200 Black 202 Royal Brown 223 Imperial Brown 238 Hickory 250 Musket Brown 280 White 713 Wicker <i>Other colors available upon request</i>	1 Per Carton 16 Lbs.
C-16		16" Trim Coil 16" x 50 Ft.	280/280 White	1 Per Carton 18 Lbs.
C-18		18" Trim Coil 18" x 50 Ft.	280/280 White	1 Per Carton 21 Lbs.
C-20		20" Trim Coil 20" x 50 Ft.	280/280 White Mill Finish	1 Per Carton 23 Lbs.

24" Quality Trim Coil

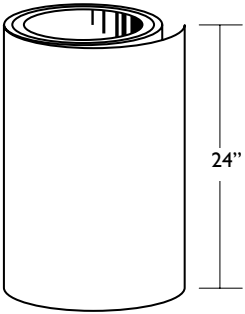
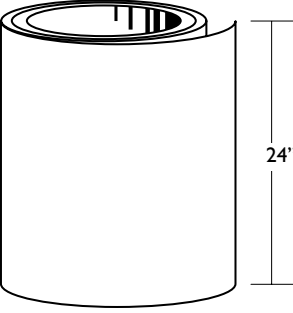
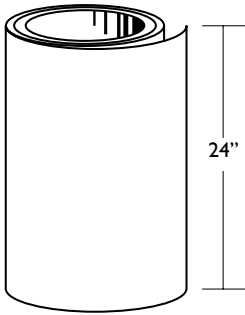
Code	Specifications	Description	Colors	
C-24	 <p>(48 Coils per skid)</p>	24" Aluminum Trim Coil 24" x 50 Ft. 26 Lbs. Per Carton	24" Aluminum Trim Coil	
			.019 Trim Coil	.024 Trim Coil
C-24 150	 <p>(18 Coils per skid)</p>	24" Aluminum Trim Coil 24" x 150 Ft. 78 Lbs. Per Carton	01 Colonial White 102 Pearl Gray 112 Tuxedo Gray 200 Black 202 Royal Brown 204 Grecian Green 214 Woodland Green 215 Autumn Red 223 Imperial Brown 238 Hickory/Clay 250 Musket Brown 280 White 360 Terratone 713 Wicker 791 Norwegian Wood 792 Heather 793 Sandcastle 801 Almond 805 Pewter 818 Bronze 819 Herringbone 820 Cranberry 821 Ivy 822 Pacific Blue 841 Buckskin 878 PVC White 230/190 Window Beige/ Brown 1288 TuffTex White	24" Coil 200 Black 202 Royal Brown 204 Grecian Green 223 Imperial Brown 238/336 Hickory/Clay 250 Musket Brown 280 White 360 Terratone 713/334 Wicker/P. Sand 780 Coppertone 818 Bronze 819 Herringbone 22" Coil 102 Pearl Gray 112 Tuxedo Gray 214 Woodland Green 325/827 Sandstone Beige/ Champagne 327 Desert Tan 355 Light Maple 791 Norwegian Wood 792 Heather 793 Sandcastle 801 Almond 805/397 Pewter/St. Gray 817/326 Cream 820 Cranberry 821 Ivy 822 Pacific Blue 901 Ivory
C-24 .024	 <p>(32 Coils per skid)</p>	DELUXE .024 24" Aluminum Trim Coil 24" x 50 Ft. 33 Lbs. Per Carton 22" x 50 Ft. 30 Lbs. Per Carton		

C-24 Coil Stock Colors

CERTAINTED / WOLVERINE

01 Colonial White
 03 Pale Ivory (901)
 04 Herringbone (819)
 07 Desert Tan (327)
 08 Soft Almond (801)
 09 Warm Sand *(793)
 11 Heritage Cream *(817)
 15 Sandstone Beige (325)
 25 Barn Red *(215)

27 Pacific Blue (822)
 28 Ivy Green (821)
 31 Snow *(109)
 32 Oxford Blue (810)
 33 Sterling Gray (805)
 34 Granite Gray (837)
 38 Sliver Ash (318)
 42 Cypress (842)
 49 Musket Brown (250)

55 Light Maple (355)
 56 Oyster Shell (356)
 59 Savannah Wicker (713)
 60 Natural Clay (238)
 75 Imperial Brown (223)
 76 Summer Wheat (376)
 77 Woodland Mist (377)

NORANDEX COIL

715 Silver
 728 Sierra *(238)

731 Cream *(817)
 733 Sand *(713)

736 Gray *(805)

* Colors are a Close Match

Trim Coil Cross- Reference Chart

238 CLAY	817 CREAM	810 BLUE	713 WICKER	792 HEATHER	801 ALMOND	805 PEWTER	819 HERRINGBONE	377 W. MIST	325 SANDSTONE BEIGE	307 VICTORIAN GRAY	305 CAMEO	715 SILVER GRAY	409 R. WICKER	793 SANDCASTLE	355 LIGHT MAPLE	318 SILVER ASH	410 R. CLAY
----------	-----------	----------	------------	-------------	------------	------------	-----------------	-------------	---------------------	--------------------	-----------	-----------------	---------------	----------------	-----------------	----------------	-------------

CRANE PERFORMANCE SIDING																	
IVORY		•															
DRIFTWOOD						•											
COUNTRY BEIGE			•														
MOCHA																•	
EGGSHELL									•								
CLAY	•																
PEARL											•						
BONE							•										
RYE																	•
SILVER												•					
HEARTLAND																	
ANTIQUÉ WHITE							•										
GRAY						•											
CREAM	•																
SIENNA								•									
BLUE			•														
SANDLEWOOD			•														
BIRCHWOOD									•								
ALMOND					•												
CLAY	•																
RMC-FAIRFIELD																	
WARM SANDLEWOOD														•			
CLASSIC SAND									•								
WICKER BEIGE			•														
SUNNY MAIZE	•																
SUMMER WHEAT														•			
ADOBE CLAY	•																
TERRA CLAY				•													
DOVE GRAY												•					
HARBOR STONE						•											
VARIFORM																	
NATURAL ALMOND					•												
ISLAND PEARL											•						
STONE MOUNTAIN	•																
GEORGIAN GRAY											•						
SILVER MIST							•										
CLASSIC CREAM		•															
SANDY TAN													•				
GRAPHITE GRAY										•							

Trim Coil Cross- Reference Chart

	793 SANDCASTLE	250 MUSKET BROWN	817 CREAM	715 SILVER GRAY	355 LIGHT MAPLE	810 SHALE	817 CREAM	801 ALMOND	810 SHALE	325 SANDSTONE BEIGE	901 ALMOND	318 SILVER ASH	819 HERRINGBONE	305 CAMEO	306 PEBBLESTONE CLAY	307 VICTORIAN GRAY	407 SAND	409 WICKER	410 CLAY
MASTIC																			
DESERT SAND	•																		
MUSKET BROWN		•																	
CLASSIC CREAM			•																
SILVER GRAY				•															
SANDSTONE					•														
EVEREST						•													
CAMEO 305														•					
PEBBLESTONE CLAY 306															•				
VICTORIAN GRAY 307																•			
ROYAL																			
SADDLE							•												
ALMOND								•											
STERLING				•															
BLUE									•										
LINEN										•									
BEIGE											•								
VINTAGE CREAM			•																
HICKORY												•							
DRIFTWOOD													•						
SAND 407																	•		
WICKER 409																		•	
CLAY 410																			•

COLOR FINISH NAILS CFN 114

1-1/4" Stainless Steel Trim Nails – 1 Lb. Boxes

102/805 Pearl Gray/Pewter	238/728 Hickory/Sierra	715 Silver	819 Herringbone
112 Tuxedo Gray	250 Musket Brown	793 Sandcastle	821 Ivy
190 Brown	280 White	791/350 Norwegian Wood/ Sandtone	822 Pacific Blue
200 Black	318 Silver Ash	792 Heather	832 Ice
202/223 Royal/Imperial Brown	325/827 Sandstone/Champagne	801 Almond	836 Wheat
204/214 Grecian/Woodland Green	327 Desert Tan	810/396 Shale/Oxford Blue	837 Granite Gray
209/820 Scotch Red/Cranberry	355 Light Maple	817/326 Cream	841 Buckskin
215 Barn Red	360 Terratone	818 Bronze	842 Cypress
224 Woodstock Tan	713/334 Wicker/P. Sand		901 Ivory
230 Beige			

Gutter Coil & Mini Gutter Coil

GUTTER COIL

GC027

Approximately 350 Lb. Rolls

6GC032

.027 x 11.75" packaged 3 coils per skid & .032 x 15" packaged 2 coils per skid

MINI GUTTER COIL

MGC150

150 Foot Coils - Boxed 1 Coil per box

6MGC150

.027 x 11.75" approx. 60 Lbs. per box & .032 x 15" approx. 83 Lbs. per box

Gutter & Accessories

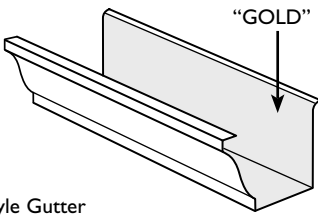
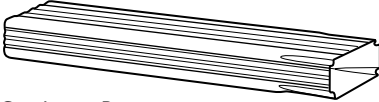
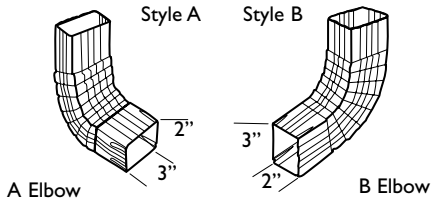
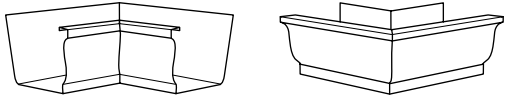
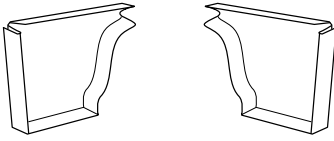
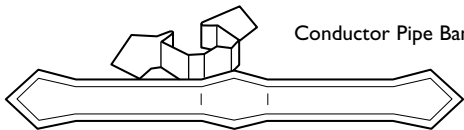
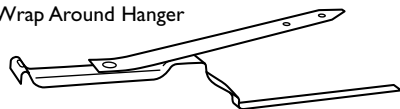
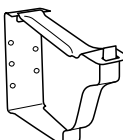
Code	Description	Colors	Carton Contents	
5K-10	 <p>5K Style Gutter</p>	All Gutter Colors	100 Ft. Per Carton (10 - 10' Pieces)	40 Lbs.
5K-16			160 Ft. Per Carton (10 - 16' Pieces)	58 Lbs.
5K-20			200 Ft. Per Carton (10 - 20' Pieces)	73 Lbs.
5K-21			210 Ft. Per Carton (10 - 21' Pieces)	77 Lbs.
5K-30			180 Ft. Per Carton (6 - 30' Pieces)	65 Lbs.
	<i>Special Lengths Priced by the Foot</i>			
CP	 <p>Conductor Pipe</p>	All Gutter Colors	100 Ft. Per Carton (10 - 10' Pieces)	25 Lbs.
CP-8			80 Ft. Per Carton (10 - 8' Pieces)	
AE		All Gutter Colors	75° Degree Bend 30 Pieces Per Carton	7 Lbs.
BE				
5INM	 <p>Inside Mitre Outside Mitre</p>	All Gutter Colors	20 Pieces Per Carton	7 Lbs.
50TM				
5ENL	 <p>Left End Cap Right End Cap</p>	All Gutter Colors	50 Pieces Per Carton	5 Lbs.
5ENR				
CPB	 <p>Conductor Pipe Band</p>	All Gutter Colors	100 Pieces Per Carton	5 Lbs.
5HWA	 <p>Wrap Around Hanger</p>	Low Gloss White High Gloss White Colors Upon Request	100 Pieces Per Carton	12 Lbs.
5FAB	 <p>Fascia Brackets</p>	Low Gloss White High Gloss White Colors Upon Request	100 Pieces Per Carton	12 Lbs.



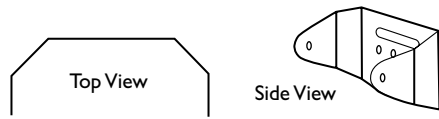
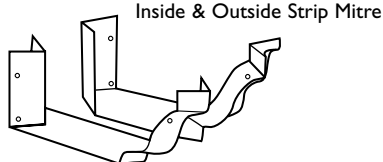
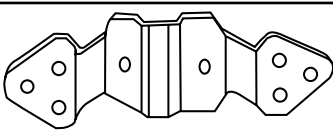
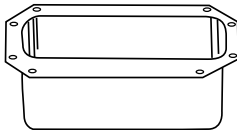
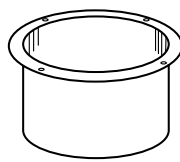
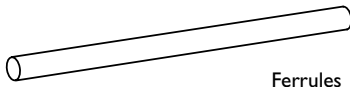
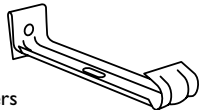
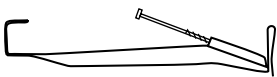

Gutter Accessories

Code	Description	Colors	Carton Contents	
7SPKA	 Spikes	All Gutter Colors	500 Pieces Per Carton	16 Lbs.
PIPE CLIPS	 Top View Side View	30° & 80° Gloss 202 Royal Brown	50 Pieces Per Carton	4 Lbs.
5ISM 50SM	 Inside & Outside Strip Mitre	30° & 80° Gloss White Only	20 Pieces Per Carton	4 Lbs.
BIS BOS			20 Pieces Per Carton	
CLEAT-W	 Cleat	White Only	100 Pieces Per Carton	3 Lbs.
OUT	 2 x 3 Outlet Tube	Mill Finish	30 Pieces Per Carton	3 Lbs.
ROUT	 2 3/8" Round Outlet Tube	Mill Finish	250 Pieces Per Carton	15 Lbs.
5FER	 Ferrules	Mill Finish	500 Pieces Per Carton	5 Lbs.
5HDHNGER	 Hidden Hangers	Mill Finish	1000 Pieces Per Carton	50 Lbs.
5HHSCREW		Mill Finish	500 Pieces Per Carton	25 Lbs.

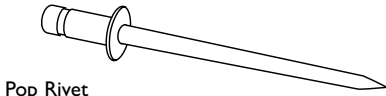

Gutter Colors

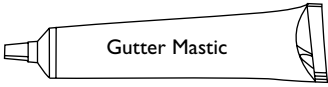
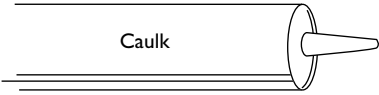
130 Low Gloss	223 Imperial Brown	713/334 Wicker/P. Sand	818 Bronze
180 High Gloss	238/336 Hickory/N. Clay	791 Norwegian Wood	819 Herringbone
102 Pearl Gray	250 Musket Brown	792 Heather	820 Cranberry
112 Tuxedo Gray	325/827 Sandstone Beige/ Champagne	793 Sandcastle	821 Ivy
200 Black	327 Desert Tan	801 Almond	822 Pacific Blue
202 Royal Brown	355 Light Maple	805/397 Pewter/St. Gray	841 Buckskin
204 Grecian Green	360 Terratone	817/326 Cream	901 Ivory
214 Woodland Green			

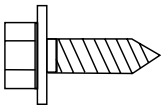
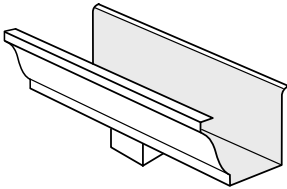
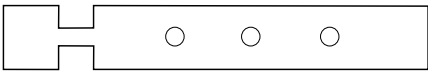
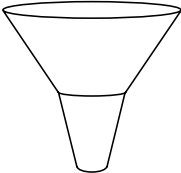
Gutter & Accessories

Code	Description	Colors	Carton Contents	
PR	 <p>Pop Rivet</p>	All Gutter Colors	100 Pieces Per Bag 10 Bags Per Box 15,000 Pieces Per Master	3 Lbs./Box
GMI2000	 <p>Gutter Mastic</p>	Silver	12 Pieces Per Carton (12 - 10 oz. Cartridges)	12 Lbs./Box
GM8000	 <p>Gutter Mastic</p>	Silver	24 Pieces Per Carton (24 - 8 oz. Tubes)	12 Lbs./Box
CAULK	 <p>Caulk</p>	Siding and Soffit Colors	Caulking Compound OSi Quad 4 Caulk (12 - 10 oz. Cartridges)	12 Lbs./Box
TUPS	 <p>Spray Paint</p>	Gutter Colors	Touch Up Paint Spray (12 - 12 oz. Cans)	13 Lbs./Box
ZIP SCREWS	 <p>6 x 3/8"</p>	102/805, 105, 200, 202, 204/214, 223, 238, 250, 280, 360, 713, 801/817, 819, 820, 821	Zip Screws 100 Pieces Per Bag	
5ENS		130 Low Gloss 180 High Gloss	End Section with Outlets 30 Pieces Per Carton	12 Lbs./Box
5HHSTRAP	 <p>Hidden Hanger Straps</p>	Mill Finish	Hidden Hanger Straps 100 Pieces Per Carton	2 Lbs./Box
FUNW130		130 Low Gloss	3 in. Funnels 12 Pieces Per Carton	4 Lbs./Box

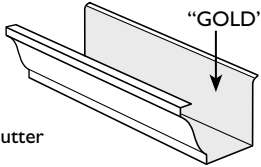
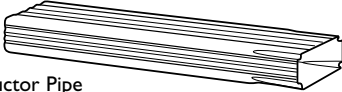
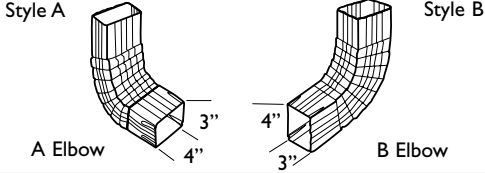
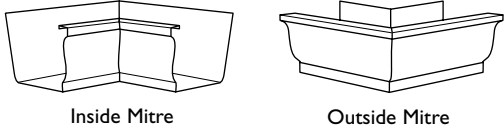
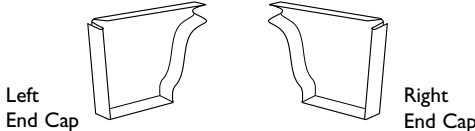
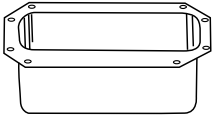
Gutter & Accessories

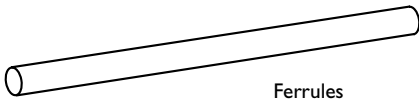
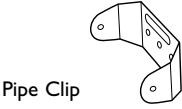
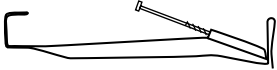
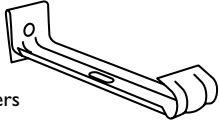
Code	Description	Colors	Carton Contents	
6K2032	 <p>6K Style Gutter</p>	All 6" Gutter Colors	200 Feet Per Carton (10 - 20 Foot Pieces)	110 Lbs.
6K3032			180 Feet Per Carton (6 - 30 Foot Pieces)	99 Lbs.
6CP	 <p>Conductor Pipe</p>	All 6" Gutter Colors	100 Feet Per Carton (10 - 10 Foot Pieces)	30 Lbs.
6AE 6BE	 <p>Style A A Elbow 3" 4" Style B B Elbow 4" 3"</p>	All 6" Gutter Colors	75° Degree Bend 15 Pieces Per Carton	6 Lbs.
6INM 6OTM	 <p>Inside Mitre Outside Mitre</p>	All 6" Gutter Colors	20 Pieces Per Carton	12 Lbs.
6ENL 6ENR	 <p>Left End Cap Right End Cap</p>	All 6" Gutter Colors	50 Pieces Per Carton	5 Lbs.
6OUT	 <p>3 x 4 Outlet Tube</p>	Mill Finish	50 Pieces Per Carton	5 Lbs.
8SPKA	 <p>8" Spikes</p>	All 6" Gutter Colors	500 Pieces Per Carton	17 Lbs.
6FER	 <p>Ferrules</p>	Mill Finish	475 Pieces Per Carton	5 Lbs.
6PIPECLIPS	 <p>Pipe Clip</p>	Low Gloss Royal Brown	50 Pieces Per Carton	4 Lbs.
6HHSREW		Mill Finish	300 Pieces Per Carton	15 Lbs.
6HDHNGER	 <p>Hidden Hangers</p>	Mill Finish	500 Pieces Per Carton	25 Lbs.

6" Gutter Colors

130 Low Gloss
180 High Gloss

202 Royal Brown
238 Hickory

250 Musket Brown
713 Wicker

FREIGHT AND TRANSPORTATION POLICY

All shipments of aluminum and vinyl building products (including drop shipments) are subject to routing by the traffic department.

MINIMUM ORDER REQUIREMENTS FOR PREPAID SHIPMENTS VIA QUALITY TRANSPORTATION

Zone 1: 0-250 miles – \$2000 minimum order required. Orders less than \$2000 – Flat rate charge of \$50.

Zone 2: 251-500 miles – \$3000 minimum order required. Orders less than \$3000 – Flat rate charge of \$150.

Zone 3: 501-800 miles – \$5000 minimum order required. Orders less than \$5000 – Flat rate charge of \$250.

Zone 4: 801-1200 miles – \$8000 minimum order required. Orders less than \$8000 – Flat rate charge of \$300.

All merchandise will be shipped via quality transportation whenever possible and will be shipped at our convenience. If the customer requests the shipment to be shipped via common carrier, the following will apply:

MINIMUM ORDER REQUIREMENTS FOR PREPAID SHIPMENTS VIA COMMON CARRIER

Zone 1: 0-750 miles: 8000 Lbs. minimum order for prepaid shipment within the 750 mile radius. Orders less than 8000 Lbs. subject to applicable freight charges shipped via common carrier from Hastings, MI.

Zone 2: 751-1200 miles: 12,000 Lbs. minimum order for prepaid shipment within the 1200 mile radius. Orders less than 12,000 Lbs. subject to applicable freight charges shipped via common carrier from Hastings, MI.

The use of a common carrier or quality transportation will be at the discretion of the shipping department in accordance with sound shipping practices.

BACK ORDERS: Original orders shipped 90% complete by item, will be considered complete. Valid back order items (less than 90%) will be shipped prepaid on our truck with customers next order.

Freight charges for all shipments that do not meet the minimum requirement for a prepaid shipment will be added to the invoice as freight charges.

MERCHANDISE RETURN POLICY

No returns will be accepted until a material return authorization form has been processed and approved by the sales office.

1. All authorized returns will be subject to a 20% service charge and return freight charges where applicable.
2. Items ordered as “specials,” broken cartons, or damaged material are not returnable for credit.
3. Credit will not be issued for materials purchased after a period of ninety days (90) from invoice date.
4. In order to process your credit it is necessary to have invoice numbers and date of the original purchase.

BROKEN CARTON POLICY

A 20% up-charge will be assessed on all broken cartons.

General Product Specification Sheet

All aluminum products are made of 3105 or equivalent aluminum alloy and H-16 or equivalent hardness.

THICKNESS

.017” Nominal - Siding, Soffit, Trim Coil and Accessories

.022” Nominal - Siding, Fascia & Trim Coil

.027” Nominal - Gutter Coil

.032” Nominal - Commercial Gutter Coil

(All values for aluminum thickness are nominal values and have a variance of $\pm .002$)
Soffit Panels are offered in Solid or Vented

COATING SPECIFICATIONS

Coatings: Kel Coating / BASF Polyesters 03 Line BASF (Tuff Tex)

Gloss: 8 to 12 on 60 degree digital gloss meter. ASTM Test D523-80.

Exterior Exposure: Fade shall not exceed more than 8 color difference units within 5 years. ASTM Test D2244-79.

Chalk: No greater than #8 rating (excluding white) within 5 years. ASTM Test D659-74.

Dry Film Thickness: .80 to .90 Mils.

Application: Roll Coat-One coat finish applied onto a chemically cleaned aluminum substrate. Paint coats are baked on finish.

Dissimilar Materials: Caution must be exercised when aluminum is placed in contact with materials or materials not compatible with aluminum. Aluminum nails or fasteners must be used when installing siding and accessories.

ASTM: Meets standards B203.

Free Air Flow Values for Vented Soffit are as Follows:

SQUARE INCH PER LINEAR FOOT

1. LVPI0=10 Sq. In.

2. LVPI2=7.2 Sq. In.

3. LVPT4=14 Sq. In.

4. CVPT4=4.9 Sq. In.

5. LVPQ4=9.5 Sq. In.

6. CVPQ4=4.75 Sq. In.